

Solarspot D-25 & D-38 price guide

The price of Solarspot system is determined by the length of tube required. To determine the price of kit that you need take a measurement of the distances A & B, add them together and then divide by two. Now round this up to the nearest kit length.

E.g. A measurement 2.0m, B measurement 1.5m would give an average of 1.75, so rounded up would be 1.8m.

Please don't forget to check the distance between the joists to ensure the system you choose will fit through the gap.

Solarspot D-25 – 250mm diameter

0.6m	- £332.40
1.0m	- £374.40
1.2m	- £396.00
1.3m	- £406.80
1.5m	- £422.40
1.6m	- £446.40
1.7m	- £453.60
1.8m	- £464.40
2.0m	- £480.00
2.1m	- £504.00
2.3m	- £511.20
2.4m	- £522.00
2.6m	- £537.60
3.1m	- £571.20
3.5m	- £602.40
3.8m	- £628.80
4.0m	- £660.00
4.5m	- £705.60
5.0m	- £794.40

Solarspot D-38 – 380mm diameter

0.6m	- £387.00
1.0m	- £441.00
1.2m	- £475.20
1.3m	- £486.00
1.5m	- £504.00
1.6m	- £536.40
1.7m	- £547.20
1.8m	- £558.00
2.0m	- £576.00
2.1m	- £608.40
2.3m	- £619.20
2.4m	- £630.00
2.6m	- £648.00
3.1m	- £681.60
3.5m	- £724.80
3.8m	- £753.60
4.0m	- £796.80
4.5m	- £849.60
5.0m	- £931.20

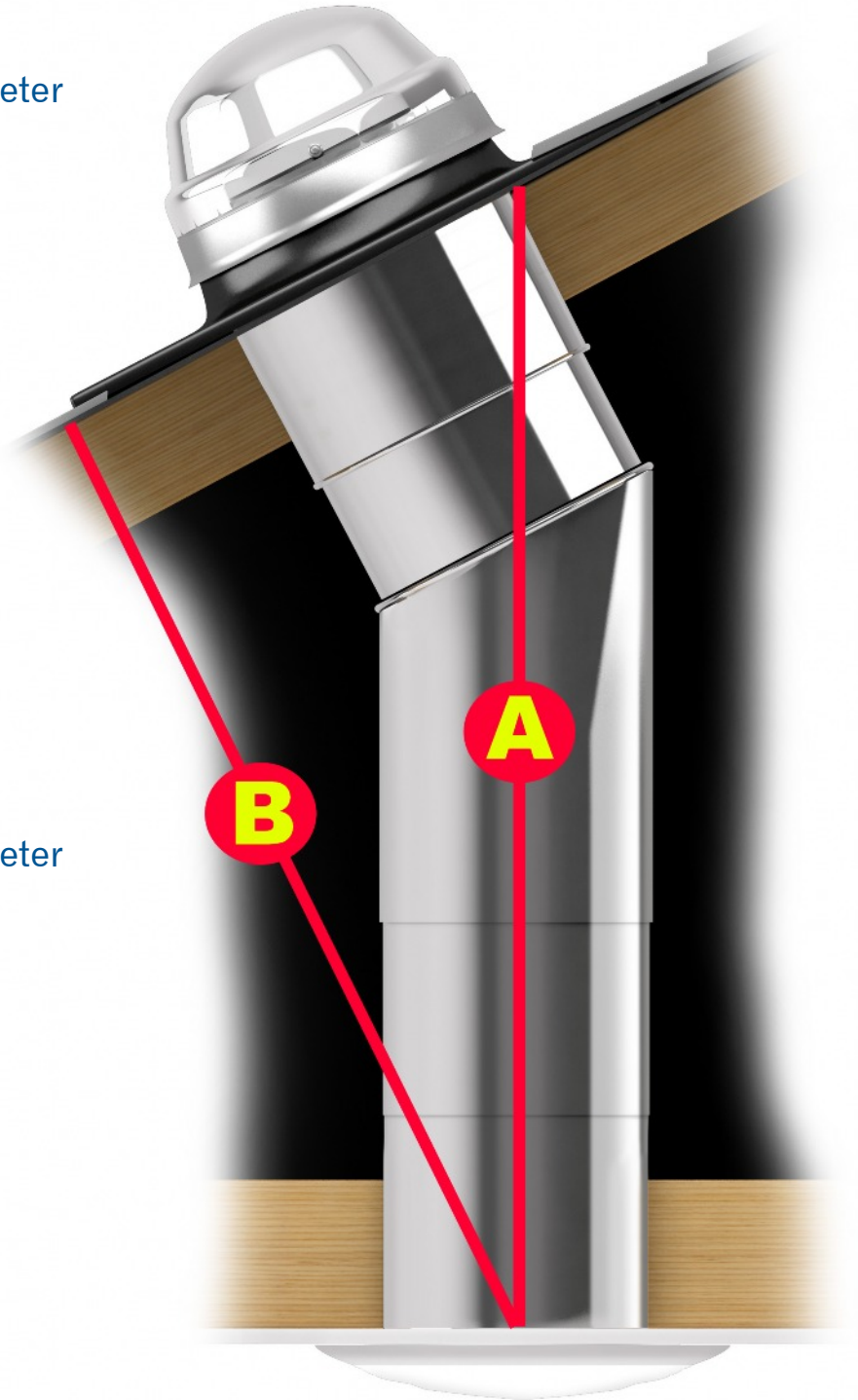

Prices include VAT and delivery

Just call 01908 299117 for assistance or information.

